

Application example

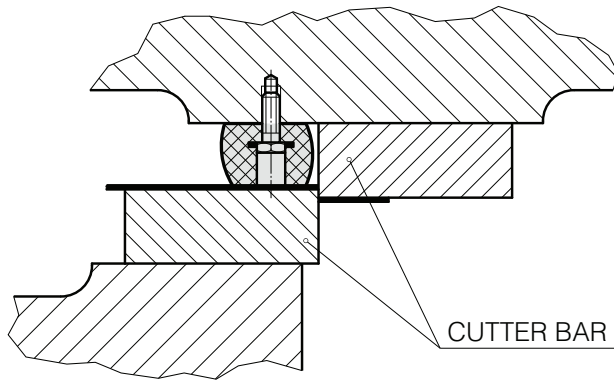

CUTTER BAR



Notes

Material: Elastomer 70 SH

Standard OMCR

C17.40.11270

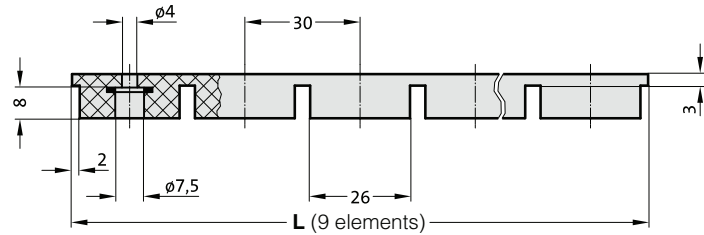
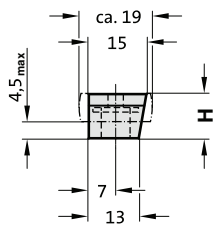

C17.40.16270

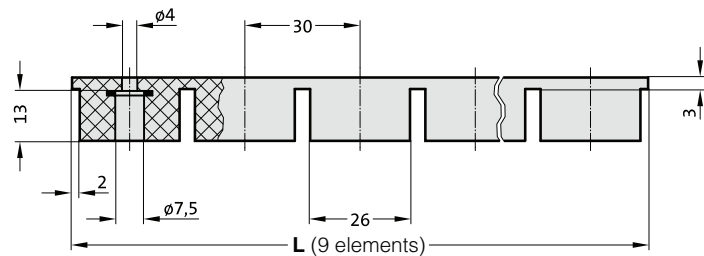
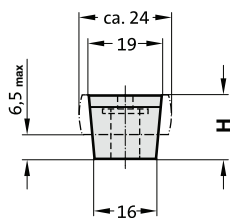

C17.40.27306

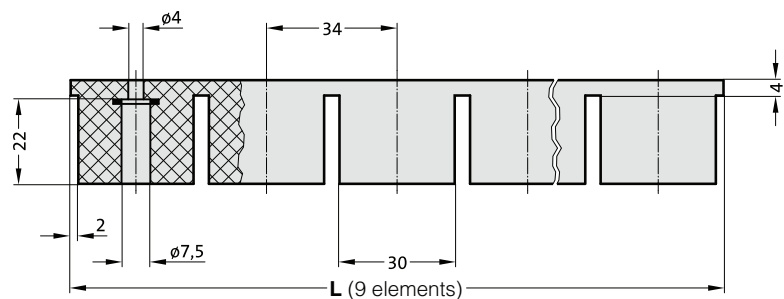
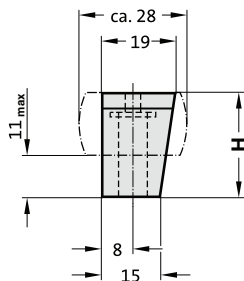

Art.	H=11,5	L=270
C17.40.	11	270

OMCR CODE	H	L
C17.40.11270	11,5	270
C17.40.16270	16,5	270
C17.40.27306	27	306