

PRESSURE PLATE - DRUCKPLATTE - PIASTRA DI REAZIONE

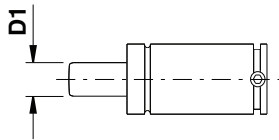

STOCK

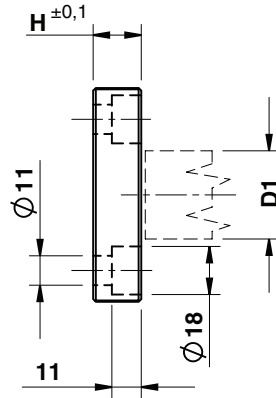
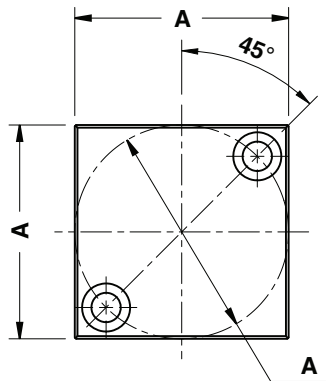
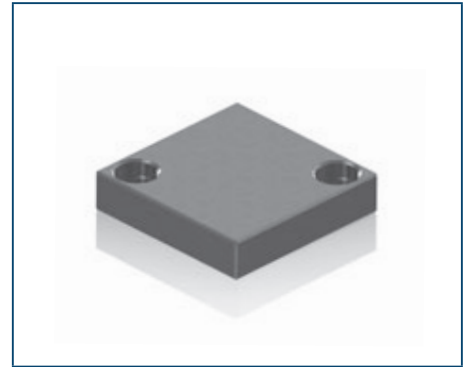

Notes

**Material:** 16MnCr5  
**HRC:** 58÷60



Art.	A=80	H=18
C12.22.	80	18

OMCR CODE	A	D1	H
C12.22.8018	80	≤ 65	18

Standard OMCR

PRESSURE PLATE - DRUCKPLATTE - PIASTRA DI REAZIONE

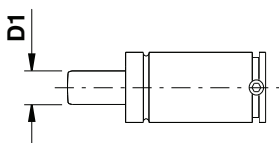
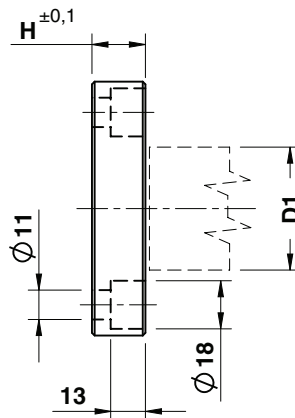
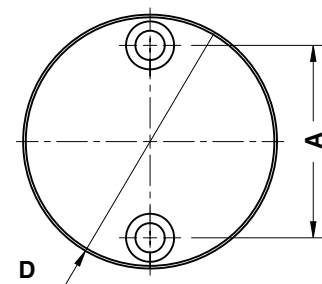

STOCK



Notes

**Material:** 16MnCr5  
**HRC:** 58÷60



Art.	D=95	H=20
C12.23.	95	20

OMCR CODE	A	D	D1	H
C12.23.6520	42	65	≤ 25	20
C12.23.9520	72	95	≤ 50	20