



SW

Il nuovo codice sarà fornito solo ad esaurimento del vecchio

The new code will be supplied only when the old will be out of stock

ACTIVE SAFETY



OSAS

Der neue Kode wird nur angegeben, wenn der alte nicht mehr lieferbar ist

Le nouveau code sera fourni uniquement lorsque le vieux stock sera écoulé

El nuevo código será suministrado sólo cuando se agoten las existencias del antiguo

O novo código irá ser fornecido apenas quando o antigo esgotar stock



USAS

easu MANIFOLD p. 247



OPAS

* F_{1i} = Isothermal end force at 100% Cu p. 16

** F_{1p} = Polytrophic end force at 100% Cu

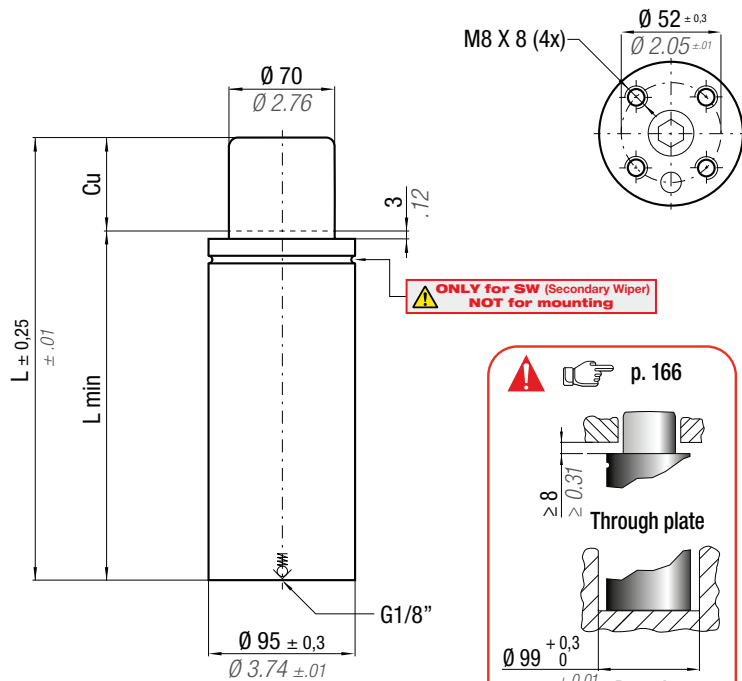

N ₂		0 - 80 °C 32 - 176 °F	ΔP ± 0,33 %/°C	P max 200 bar 2900 psi	P min 20 bar 290 psi	S 38,48 cm ² 5.964 in ²	SPM ~ 20 - 60 (at 20°C)	Max Speed 1,6 m/s	Maintenance kit 39BMMML07500C	
CODE	NEW	Cu	L	L min	F ₀	F _{1i} *	F _{1p} **	V ₀		
PHASING OUT from 05/2019		mm inch	mm inch	mm inch	Initial force daN lb	End force * daN lb	End force ** daN lb	cm ³ in ³	~Kg ~lb	2014/68/EU
ML 7500 - 015 - C	ML 7500 - 015 - D	15 0.59	115 4.53	100 3.94	7700 17310	10242 23024	11406 25641	295 17.98	3,30 7.28	✓
ML 7500 - 025 - C	ML 7500 - 025 - D	25 0.98	135 5.31	110 4.33	± 5%	11442 25722	13037 29308	368 22.48	3,58 7.89	✓
ML 7500 - 038 - C	ML 7500 - 038 - D	38 1.50	165 6.50	127 5.00	200 bar	12326 27709	14261 32060	484 29.56	4,01 8.84	✓
ML 7500 - 050 - C	ML 7500 - 050 - D	50 1.97	190 7.48	140 5.51	2900 psi	13083 29411	15324 34449	578 35.27	4,36 9.61	✓
ML 7500 - 063 - C	ML 7500 - 063 - D	63 2.48	220 8.66	157 6.18		13519 30391	15942 35838	694 42.34	4,75 10.47	✓
ML 7500 - 080 - C	ML 7500 - 080 - D	80 3.15	260 10.24	180 7.09	+20 °C +68 °F	13883 31210	16462 37007	849 51.82	5,36 11.82	✓

KIT FOR LINKING

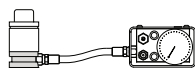

code: 39FML07500B



Seal (1x)



Washer (6x)



Screw (3x)



Bottom base (1x)



Valve (1x)



Instructions



Sostituire ogni 1.000.000 di cicli. Replace every 1 million cycles. Nach 1 Mio. Hübe austauschen. Reemplazar cada 1 millón de ciclos. Substituir a cada 1 milhão de ciclos.

Bottom base dimension

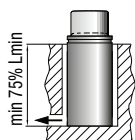
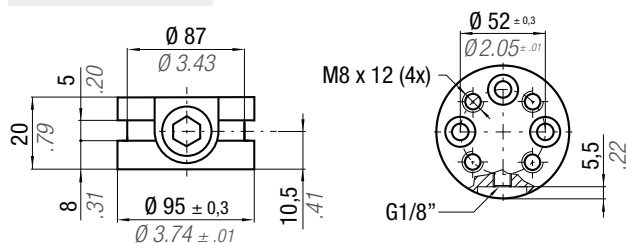

Drop-In

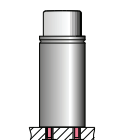

Bottom mount

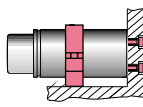

FSA 95 - FSD 95
FSE 95

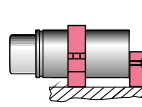

FSD 95 + R 95 A
FSE 95 + R 95 A

HOW TO ORDER

p. 167

INSTALLATION GUIDELINE

p. 205